

PRODUCT CATALOG

Aspect™ Series Imaging Tables

Mobile Video Display System

Table Accessories & Consumables

Quality products for surgical, interventional and diagnostic imaging



Image Diagnostics, Inc.
310 Authority Drive
Fitchburg, MA 01420

www.imagediagnostics.com

August 2012 D000-495 REV S

idi

Image Diagnostics, Inc.

Safety, Simplicity, Quality

CONTENTS

| | |
|--|--------------|
| Aspect Series Tables | |
| Key Features..... | 2 |
| Applications Selection Chart..... | 2 |
| Tabletop Selections..... | 3 |
| Pain Management and General Purpose Tables..... | 4-5 |
| Vascular and Interventional Tables, with 4-way Floating Tops | 6-9 |
| Swallow Studies – Upright Tilting Table..... | 10 |
| Urology and Gynecology Tables..... | 11-12 |
| | |
| Table Specification and Accessory Matrix | |
| Pain Management & General Purpose Tables..... | 13 |
| Vascular Tables with 4-way Floating Tops..... | 14 |
| | |
| Table Accessories - General | |
| Tabletop Extensions..... | 15 |
| Armboards and Rail-Mounted Accessories..... | 16-17 |
| Radiation Shields, Table Mounted..... | 17-18 |
| Facial Support and Spinal Imaging Accessories..... | 18 |
| Straps and Replacement Armboard Pads..... | 19 |
| | |
| Urology Table Accessories..... | 20-21 |
| | |
| Hand & Footswitch Controls..... | 22-23 |
| | |
| MDS Mobile Video Display System..... | 24-26 |

IDI Aspect Series Tables are ETL Listed (IEC, UL & CSA Standards) and CE marked.
Technical Specifications are subject to change without notice.

Aspect Series Tables... C-arm Imaging At Its Best

All Aspect Series tables with cantilevered tabletops are designed to provide these advantages...

- Long, slim-profile wheel base for...
 - Excellent stability and safety
 - Unencumbered C-arm access
 - Very low table weight for easy maneuverability and transport
- Small base pedestal and very large, unencumbered imaging areas: 59 – 72 inches (150 – 183cm), depending on model
- High-quality, carbon fiber tops for excellent fluoroscopic imaging with minimal x-ray attenuation
- Highest quality mechanical components for exceptional durability and reliability.
- Sleek, easy-to-clean base and covers
- Multiple table top styles for optimal design and performance based on customer clinical requirements
- A common platform for a wide range of motorized and manual movements
 - Application-specific designs, *the right price-performance solution for every customer*



- ✓ Superior C-arm access
- ✓ Exceptional stability & safety
- ✓ **Both** low table weight *and*...
- ✓ High patient weight capacity
- ✓ Durable and easy-to-clean design



Aspect Series Imaging Tables Application Selection Chart

| Model | Pain Mgmt. | Ortho, G.I. & General | Vascular & Interventional | Bariatric Swallow Studies | Urology & GYN |
|--------------------|------------|-----------------------|---------------------------|---------------------------|------------------|
| EZ-Access | ● | ● | | | |
| 100 - 100RT | ● | ● | | | |
| 100RTL | ● | ● | ○ | | |
| 100-4 | | | ● | | |
| 100-4T | | | ● | | |
| ISR | | | ● | | |
| HIGH-TILT | | | | ● | |
| 100UCPlus | ○ | ○ | | | ● |
| 100US | | | | | Fertility Clinic |

Tabletop Selections for Aspect Mobile Imaging Tables

All Aspect Series Tabletops feature very low attenuation, carbon fiber construction. Standard tops may be substituted with optional sizes/styles as shown below at no extra charge.

Aspect 100, 100E, EZ-Access, 100T, 100R, 100RT and 100RTL Tabletops



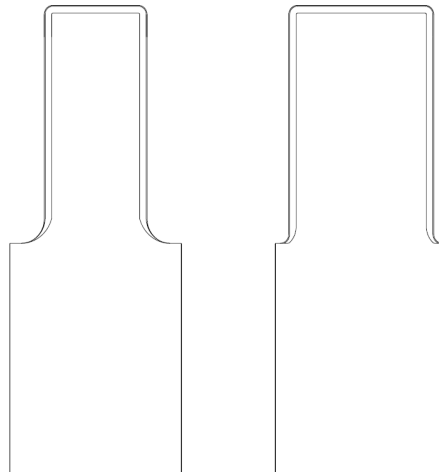

| Standard | Optional |
|-------------------------|--|
| X100-995 | X100-733 |
| 24" x 80" 61 x 203cm | 22" x 80" 56 x 203cm <i>with facial cutout</i> |

Aspect 100-4 Tabletops





| Standard | Optional |
|--|--|
| X100-517 | X100-982 |
| 18" - 30" W x 80" L 45.7 - 76.2 x 203cm | 23.5" - 30" W x 80" L 59.4 - 76.2 x 203cm |



Tables for Pain Management and General C-arm Imaging Applications

| Catalog No. | Model & Description | Specifications |
|-------------|--|--|
| A100-203 | <p>Aspect 100 Fluoroscopic Procedure Table, Fixed Height</p>  | <ul style="list-style-type: none"> Carbon fiber tabletop with low x-ray attenuation Tabletop: 24" x 80" (61 x 203 cm) Optional Tabletop: 22" x 80" (56 x 203 cm) with facial cutout 66" (167.6 cm) unobstructed imaging area 39" (99 cm) tabletop height, including 2" tabletop pad <ul style="list-style-type: none"> Customer may specify different height at time of order Locking swivel casters 450 lb. (204 kg) patient weight capacity Table weight = 250 lbs. (113 kg) <p>Accessories included:</p> <ul style="list-style-type: none"> Tabletop Pad, 2" thick |
| A100-402 | <p>Aspect 100E Fluoroscopic Procedure Table with Motorized Elevation</p>  | <ul style="list-style-type: none"> Carbon fiber tabletop with low x-ray attenuation Tabletop: 24" x 80" (61 x 203 cm) Optional Tabletop: 22" x 80" (56 x 203 cm) with facial cutout 66" (167.6 cm) unobstructed imaging area Motorized tabletop elevation 28" – 39.8" (71 – 101 cm), including 2" tabletop pad Locking swivel casters 450 lb. (204 kg) patient weight capacity Table weight = 350 lbs. (158 kg) 120 VAC operation (230 VAC optional) Battery back-up operation <p>Accessories included:</p> <ul style="list-style-type: none"> Pendant Hand Control Tabletop Pad, 2" thick Patient Restraint Straps Facial cushion, crescent shape Disposable covers for facial cushion, box of 50 |
| A100-2100 | <p>Aspect EZ-Access Fluoroscopic Procedure Table with Motorized Elevation and Very Low Minimum Height</p>  | <ul style="list-style-type: none"> Carbon fiber tabletop with low x-ray attenuation Tabletop: 24" x 80" (61 x 203 cm) Optional Tabletop: 22" x 80" (56 x 203 cm) with facial cutout 68" (172.7 cm) unobstructed imaging area Motorized tabletop elevation 21" – 40" (53 – 102cm), including 2" tabletop pad Locking swivel casters 450 lb. (204 kg) patient weight capacity Table weight = 490 lbs. (222 kg) 120 VAC operation (230 VAC optional) Battery back-up operation <p>Accessories included:</p> <ul style="list-style-type: none"> Pendant Hand Control Tabletop Pad, 2" thick Patient Restraint Straps Facial cushion, crescent shape Disposable covers for facial cushion, box of 50 |



Tables for Pain Management and General C-arm Imaging Applications *(continued)*

| Catalog No. | Model & Description | Specifications |
|-------------|---|--|
| A100-658 | <p>Aspect 100T Fluoroscopic Procedure Table, with Motorized Elevation and Trendelenburg Tilt</p>  | <ul style="list-style-type: none"> • Carbon fiber tabletop with low x-ray attenuation • Tabletop: 24" x 80" (61 x 203 cm) • Optional Tabletop: 22" x 80" (56 x 203 cm) with facial cutout • 62" (157.5 cm) unobstructed imaging area • Motorized tabletop movements: <ul style="list-style-type: none"> - Elevation 30" – 41.8" (76 – 106 cm), including 2" tabletop pad - Trendelenburg Tilt $\pm 15^\circ$ • Locking swivel casters • 450 lb. (204 kg) patient weight capacity • Table weight = 350 lbs. (158 kg) • 120 VAC operation (230 VAC optional) • Battery back-up operation <p>Accessories included:</p> <ul style="list-style-type: none"> • Pendant Hand Control • Tabletop Pad, 2" thick • Patient Restraint Straps • Facial cushion, crescent shape • Disposable covers for facial cushion, box of 50 |
| A100-662 | <p>Aspect 100R Fluoroscopic Procedure Table, with Motorized Elevation and Lateral Roll</p>  | <ul style="list-style-type: none"> • Carbon fiber tabletop with low x-ray attenuation • Tabletop: 24" x 80" (61 x 203 cm) • Optional Tabletop: 22" x 80" (56 x 203 cm) with facial cutout • 62" (157.5 cm) unobstructed imaging area • Motorized tabletop movements: <ul style="list-style-type: none"> - Elevation 30.5" – 42" (77.5 – 106.7 cm), including 2" tabletop pad - Lateral Roll $\pm 20^\circ$ • Locking swivel casters • 450 lb. (204 kg) patient weight capacity • Table weight = 395 lbs. (179 kg) • 120 VAC operation (230 VAC optional) • Battery back-up operation <p>Accessories included:</p> <ul style="list-style-type: none"> • Pendant Hand Control • Tabletop Pad, 2" thick • Patient Restraint Straps • Facial cushion, crescent shape • Disposable covers for facial cushion, box of 50 |

Tables for Pain Management and General C-arm Imaging Applications *(continued)*

| Catalog No. | Model & Description | Specifications |
|-------------|---|---|
| A100-870 | <p>Aspect 100RT Fluoroscopic Procedure Table, with Motorized Elevation, Trendelenburg Tilt and Lateral Roll</p>  | <ul style="list-style-type: none"> Carbon fiber tabletop with low x-ray attenuation Tabletop: 24" x 80" (61 x 203 cm) Optional Tabletop: 22" x 80" (56 x 203 cm) with facial cutout 62" (157.5 cm) unobstructed imaging area Motorized table movements: <ul style="list-style-type: none"> Elevation 32.4" – 44.2" (82 – 112 cm), including 2" tabletop pad Trendelenburg Tilt $\pm 15^\circ$ Lateral Roll $\pm 20^\circ$ Auto return-to-level button and positional memory Locking swivel casters 450 lb. (204 kg) patient weight capacity Table weight = 425 lbs. (193 kg) 120 VAC operation (230 VAC optional) Battery back-up operation <p>Accessories included:</p> <ul style="list-style-type: none"> Pendant Hand Control Tabletop Pad, 2" thick Patient Restraint Straps Facial pad, crescent shape Disposable covers for facial pad, box of 50 |
| A100-1254 | <p>Aspect 100RTL Fluoroscopic Procedure Table, with Motorized Elevation, Trendelenburg Tilt, Lateral Roll and Longitudinal Tabletop Motion</p>  | <ul style="list-style-type: none"> Carbon fiber tabletop with low x-ray attenuation Tabletop: 24" x 80" (61 x 203 cm) Optional Tabletop: 22" x 80" (56 x 203 cm) with facial cutout 59" (150 cm) unobstructed imaging area Motorized table movements with hand control <ul style="list-style-type: none"> Elevation 33.2" – 43.2" (84 – 109.7 cm), including 2" tabletop pad Trendelenburg Tilt $\pm 15^\circ$ Lateral Roll $\pm 20^\circ$ Longitudinal tabletop travel = 10" (25.4 cm) Auto return-to-level button and positional memory Locking swivel casters 450 lb. (204 kg) patient weight capacity Table weight = 460 lbs. (209 kg) 120 VAC operation (230 VAC optional) Battery back-up operation <p>Accessories included:</p> <ul style="list-style-type: none"> Pendant Hand Control Tabletop Pad, 2" thick Patient Restraint Straps Facial cushion, crescent shape Disposable covers for facial cushion, box of 50 |
| Z100-1628 | Stainless Steel Base Cover Option for 100E, 100T, 100R, 100RT |  |
| Z100-1629 | Stainless Steel Base Cover Option for 100-4 & 100RTL | |

Tables for Vascular & Interventional Imaging Applications

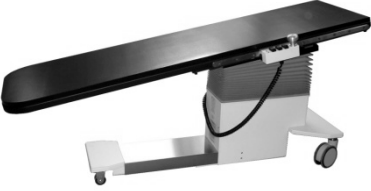
| Catalog No. | Model & Description | Specifications |
|-------------|--|---|
| A100-566 | <p>Aspect 100-4 Fluoroscopic Procedure Table with 4-way Manual Floating Tabletop and Motorized Elevation</p>  | <ul style="list-style-type: none"> • Carbon fiber tabletop with low x-ray attenuation • Tabletop = 18" / 30" x 80" (46 / 76 x 203 cm) • Optional tabletop: 23.5" / 30" x 80 (59/72 x 203 cm) • 72" (182.9 cm) unobstructed imaging area • Motorized Elevation 29.9" – 39.7" (75.9 – 100.8 cm), including 2" tabletop pad • 4-way manual floating tabletop with panning hand control <ul style="list-style-type: none"> - Longitudinal tabletop float 40" (101.6 cm) - Transverse tabletop float 10" (25.4 cm) • Locking swivel casters • 450 lb. (204 kg) patient weight capacity • Table weight = 490 lbs. (222 kg) • 120 VAC operation (230 VAC optional) • Battery back-up operation <p>Accessories included:</p> <ul style="list-style-type: none"> • Rail-mount Hand Control • Tabletop Pad & Patient Restraint Straps • ID410 Width Extender Board (lateral arms support, for 18" wide top only) |
| A100-1416 | <p>Aspect 100-4T Fluoroscopic Procedure Table with 4-way Manual Floating Tabletop, Motorized Elevation and Trendelenburg Tilt</p>   | <ul style="list-style-type: none"> • Carbon fiber tabletop with low x-ray attenuation • Tabletop = 24" x 84" (61 x 213.4 cm) • 62" (157.5 cm) unobstructed imaging area • Motorized Elevation 31" – 40.9" (78.7 – 103.8 cm), including 2" tabletop pad • Trendelenburg Tilt $\pm 10^\circ$ with auto return-to-level function • 4-way manual floating tabletop with panning hand control <ul style="list-style-type: none"> - Longitudinal tabletop float 32" (81.3 cm) - Transverse tabletop float 8" (20.3 cm) • 4-way float locked unless panning hand control is depressed and table is level • 5" swivel rear casters with electrical locking • 3" swivel dual front casters • 450 lb. (204 kg) patient weight capacity • Table weight = 605 lbs. (274 kg) • 120 VAC operation (230 VAC optional) • Battery back-up operation <p>Accessories included:</p> <ul style="list-style-type: none"> • Rail-mount Hand Control • Tabletop Pad (2" thick) & Patient Restraint Straps <p>Optional Accessories:</p> <ul style="list-style-type: none"> • Footswitch control available for elevate, tilt, and 4-way float lock-release functions • Rail-mounted radiation shield • Radiolucent and standard armboards (see "Armboards" section, page 15). |

Tables for Vascular & Interventional Imaging Applications *(continued)*

| Catalog No. | Model & Description | Specifications |
|-------------|--|---|
| A100-1902 | <p>Aspect ISR Fluoroscopic Procedure Table with 4-way Manual Floating Tabletop, Motorized Elevation, Trendelenburg Tilt and Isocentric-Roll</p>  <p style="text-align: center;"><i>Iso-Roll</i></p> | <ul style="list-style-type: none"> • Cantilevered, carbon fiber tabletop with low x-ray attenuation • Tabletop dimensions: 84" (213 cm) long, 22" (56cm) wide at imaging end of table and 24" (61cm) wide at pedestal end of table. (Note: There are two tabletop styles available on the ISR table. See tabletop options next page). • Unobstructed imaging area: 61" (155 cm) or 73" (185 cm) with optional headrest attached (optional headrest requires tabletop X100-2308). • Motorized Elevation: 8" (20.3cm) • Tabletop Height: 32" – 40" (81 – 102 cm), including 2" thick tabletop pad. • Trendelenburg Tilt: $\pm 12^\circ$ with auto stop-at-level function • Isocentric-Roll: $\pm 12^\circ$ • 4-way manual floating tabletop with panning hand control <ul style="list-style-type: none"> - Longitudinal tabletop travel: 32" (81.3 cm) - Transverse tabletop travel: 8" (20.3 cm) • Longitudinal float automatically disabled when table is in out-of-level position. Transverse float available regardless of tilt position. • Rail-mounted panning hand control for 4-way float and motorized table movements. Includes lock-out button to prevent inadvertent motorized table movements. • Multi-caster 3-position caster locking system via pedal on table base: Fully locked, Fully unlocked & Steering lock (center casters only locked) for easy transport and positioning. • Stainless steel pedestal and base covers • Patient weight capacity: 450 lbs. (204 kg) • Table weight: 605 lbs. 274 kg) • 115 VAC operation (230 VAC optional, specify on order) • Internal battery system. Full operation with or without AC power cord connected. • Warranty: 3 years parts, 1 year labor <p>Accessories included:</p> <ul style="list-style-type: none"> • Tabletop Pad, 2" • Patient Restraint Straps • Rail-mounted panning hand control for 4-way float and motorized table movements. |

Aspect ISR (continued)

| Catalog No. | Model & Description | Specifications |
|-------------|---|--|
| |  <p style="text-align: center;">ISR with optional headrest extension</p>  <p style="text-align: center;">ISR with catheter tray extension</p> | <p>Optional Accessories for Aspect ISR:</p> <ul style="list-style-type: none"> • Clamp-on accessory rail • Side-rail clamp, rotating, with socket for attachment of accessories with 5/8 inch circular post • Armboard, quick-release, rail mounted (requires Clamp-on Accessory Rail, above) • VAB Armboard; carbon fiber, one-piece, extra wide armboard for vascular access procedures (body section slides under patient/table pad). Includes strap and pad. • Arm Board, carbon fiber, shoulder mount (attaches by sliding thin section under patient/table pad), flat. Includes pad and strap. • Footswitch Control for Aspect ISR • Pendant Hand Control, for Aspect ISR (this controls elevate and tilt functions only. The rail-mounted, 4-way float panning hand control also provides these functions and is included with table) • Headrest, articulating, removable, for Aspect ISR. Requires tabletop X100-2308. (See below). • Tabletop Catheter Tray Extension, 24" wide, for 100-4T and Aspect ISR - mounts to pedestal end of table only. • Tabletop Catheter Tray Extension, 22" wide, for Aspect ISR - mounts to imaging end of table only. Requires tabletop X100-2308. (See below). • Anesthesia Screen Holder • Radiation Shield, rail-mounted |
| |   <p style="text-align: center;">Optional headrest compatible with tabletop X100-2308 only.</p> | <p style="text-align: center;">ISR Tabletop Options: Must specify top selection with order.</p> <p>Tabletop X100-2308: Short, recessed side rails 5" (13 cm) in length at imaging end of table facilitate use of removable headrest extension (not shown in diagram above) and also facilitate attachment of catheter tray extension at narrow end of table. Two separate catheter tray extensions are available - one for wide end of table and one for narrow end of table. Headrest extension and catheter tray extensions are optional and sold separately.</p> <p>Tabletop X100-2237: Does <u>not</u> include recessed side rails at imaging end of table. Catheter tray extension may be attached to wide end of table only (pedestal end of table). Optional headrest extension is <u>not</u> available with this tabletop version.</p> |

Table for Swallow Studies and Upright Imaging/Patient Loading

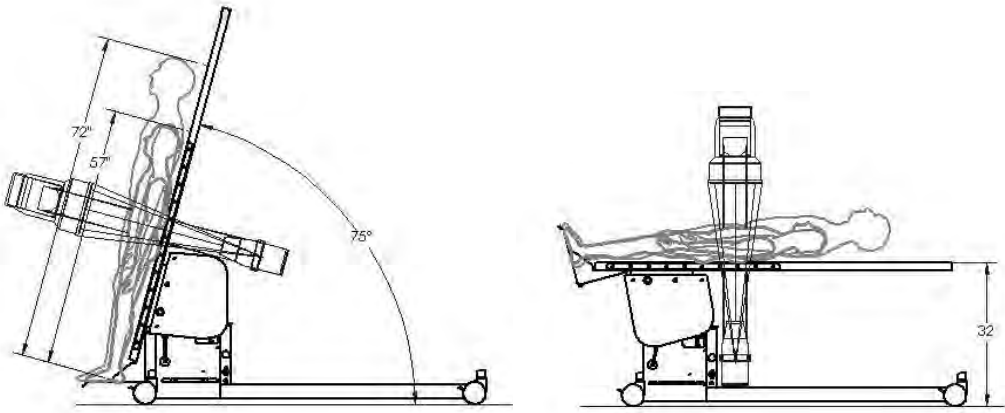
| Catalog No. | Model & Description | Specifications |
|-------------|--|--|
| A100-1708 | <p>Aspect 100HT High-Tilt™ Fluoroscopic Procedure Table</p>   | <p>Ideal Imaging Solution for:</p> <ul style="list-style-type: none"> ➤ Swallowing studies for post-surgical gastric banding adjustment ➤ Other C-arm procedures requiring upright patient imaging or loading <ul style="list-style-type: none"> • Motorized tilt from horizontal to 75° upright with footswitch operator control • Tilt speed ≈ 4°/sec. (≈ 20 seconds to full stroke) • Built-in footboard for “step-on” patient loading with table in upright position • 525 lb. (238 kg) patient weight capacity • Ultra-stable during tilt motion and in any table position • Easy C-arm imaging access in any tabletop position • Carbon fiber tabletop: artifact-free, low x-ray attenuation • Fixed tabletop height in horizontal position: 32" (81.3 cm) • Footboard position with table upright: 5" (12.7 cm) above floor • Tabletop size: 24"W x 80"L (61cm x 203cm) • Imaging area: 58" (147.3cm) • Standard US siderails (3/8" x 1 1/8") for handgrips attachment • Standard 110 volt operation with battery back-up • 5", locking casters and lightweight table for easy transport • Accessories included: <ul style="list-style-type: none"> • tabletop pad, 1" (2" thick pad optional) • patient handgrips • restraint straps • footswitch control |

Urology Table

| Catalog No. | Model & Description | Specifications |
|-------------|---|--|
| A100-1517 | <p data-bbox="313 338 727 464">Aspect 100UC Plus Urological Imaging Table, with Motorized Elevation, Trendelenburg Tilt, Longitudinal and Transverse Tabletop Motions</p>  <p data-bbox="313 1014 797 1125"><i>Leg-holders are not included and must be ordered separately. See "Urology Table Accessories", pg. 17. May also use any leg-holders with standard US table side-rail attachment.</i></p>  <p data-bbox="406 1598 704 1623"><i>Table with extension attached.</i></p> | <ul style="list-style-type: none"> • Carbon fiber tabletop with low x-ray attenuation • Motorized Tabletop motions with hand control and footswitch control: <ul style="list-style-type: none"> - Elevation: 33.3" – 43.1" (79.4 – 104.4 cm), including 2" tabletop pad - Trendelenburg Tilt: $\pm 15^\circ$ - Longitudinal tabletop travel: 10" (25.4 cm) - Transverse tabletop travel: 7" (17.8 cm) • Tabletop = 28"W x 46"L (71 x 117 cm) • Radiolucent tabletop extension, 34" L x 24" W (86 x 61 cm) • 20"L x 25"W (51 x 63.5 cm) imaging area for endourology • 34"L x 24"W (86.4 x 61 cm) imaging area on extension • Total length of radiolucent imaging area with extension attached: 54" (137 cm) • Radiographic cassette tray, loads from either side of table • 5" (12.7 cm) locking swivel casters • Patient weight capacity: <ul style="list-style-type: none"> - 525 lb. (238 kg) in endourology position with patient upper body over main tabletop section. - 400 lbs. (181 kg) with patient upper body on tabletop extension • Table weight \approx 575 lbs. (\approx261 kg) • 120 VAC operation (230 VAC optional) • Battery back-up operation • Built-in footswitch storage tray <p data-bbox="870 1087 1084 1108">Accessories included:</p> <ul style="list-style-type: none"> • Tabletop pad, 2" thick with waterproof cover • Radiolucent tabletop extension with 2" pad • Hand control pendant • Footswitch control • Collapsible and removable drain bag hoop • Disposable drain bag and hose ass'y, box of 20 • Removable Radiation Shield Flap for perineal end of table • Patient Restraint Straps • Armboards (1), rail mounted, with pad and strap • Disposable covers for footswitch and radiation shield flap, box of 50 • Stirrups mounting rail extender kit (for boot-style legholders sold by IDI or Allen Medical). |

Gynecology / Fertility Clinic Table

| Catalog No. | Model & Description | Specifications |
|-------------|--|--|
| A100-1479 | <p>Aspect 100US GYN/Fertility Clinic Mobile Imaging Table, with Motorized Elevation</p>  <p><i>Lithotomy Leg-holders are not included and must be ordered separately. See Urology Table Accessories, pg. 19. May also use any leg-holders with standard US table side-rail attachment.</i></p> | <ul style="list-style-type: none"> • Carbon fiber tabletop with low x-ray attenuation • Tabletop = 24" x 46" (61 x 117 cm) • 24" W x 32"L (61 x 81 cm) unobstructed imaging area • Motorized tabletop elevation with foot control: <ul style="list-style-type: none"> - Elevation 27" – 39" (68.5 – 99 cm), including 1" tabletop pad • Locking swivel casters • 450 lb. (204 kg) patient weight capacity • Table weight ≈ 395 lbs. (≈179 kg) • 120 VAC Operation (230VAC optional) • Battery back-up operation • Accessories included: <ul style="list-style-type: none"> • Tabletop Pad, 1" • Patient Restraint Straps |

Aspect Series Tables Specifications & Accessory Matrix

Pain Management and General Imaging Tables

| | EZ-Access | 100E | 100R | 100T | 100RT | 100RTL |
|---------------------------------------|---|---|---|---|---|---|
| Elevate (tabletop height without pad) | 19 – 38" 48 – 96.5 cm | 26 - 37.8" 66 - 96 cm | 28.5 - 40.3" 72 – 102 cm | 28 - 39.8" 71 - 101 cm | 30.4 - 42.2" 77 - 107 cm | 31.2 - 41.2" 79 - 105 cm |
| Trendelenburg Tilt | NA | NA | NA | ±15° | ±15° | ±15° |
| Lateral Tilt | NA | NA | 20° | NA | 20° | 20° |
| Longitudinal Tabletop Motion | NA | NA | NA | NA | NA | 10" 25 cm |
| Transverse Tabletop Motion | NA | NA | NA | NA | NA | NA |
| Standard Tabletop Size | 24" x 80" 61 x 203cm | 24" x 80" 61 x 203 cm | 24" x 80" 61 x 203 cm | 24" x 80" 61 x 203 cm | 24" x 80" 61 x 203 cm | 24" x 80" 61 x 203 cm |
| Optional Tabletop Size | 22" x 80" 56 x 203 cm with facial cut-out | 22" x 80" 56 x 203 cm with facial cut-out | 22" x 80" 56 x 203 cm with facial cut-out | 22" x 80" 56 x 203 cm with facial cut-out | 22" x 80" 56 x 203 cm with facial cut-out | 22" x 80" 56 x 203 cm with facial cut-out |
| Imaging Area | 68" 172.7 cm | 66" 167.6 cm | 62" 157.5 cm | 62" 157.5 cm | 62" 157.5 cm | 59" 149.9 cm |
| Patient Capacity | 450 lb. 204 kg | 450 lb. 204 kg | 450 lb. 204 kg | 450 lb. 204 kg | 450 lb. 204 kg | 450 lb. 204 kg |
| Table Weight | 490 lb. 222 kg | 350 lb. 158 kg | 395 lb. 179 kg | 350 lb. 158 kg | 425 lb. 193 kg | 460 lb. 209 kg |
| Tabletop Pad (2" thick) | ● | ● | ● | ● | ● | ● |
| Restraint Straps | ● | ● | ● | ● | ● | ● |
| Facial Support Cushion | ● | ● | ● | ● | ● | ● |
| Pendant Hand Control | ● | ● | ● | ● | ● | ● |
| Foot Control | ○ | ○ | ○ | ○ | ○ | ○ |
| Armboard, rail mounted | ○ | ○ | ○ | ○ | ○ | ○ |
| Armboard, carbon fiber | ○ | ○ | ○ | ○ | ○ | ○ |
| VAB Armboard | ○ | ○ | ○ | ○ | ○ | ○ |
| Clamp-on Accessory Rail | ○ | ○ | ○ | ○ | ○ | ○ |
| Catheter Tray extension | NA | NA | NA | NA | NA | NA |
| Table-Mounted Radiation Shield | ○ | ○ | ○ | ○ | ○ | ○ |

● = Standard Feature ○ = Optional NA = Not Available

4-Way Float Top Tables

| | 100-4 | 100-4T | ISR |
|--|----------------------------------|----------------------------|---|
| Elevate (tabletop height without pad) | 27.9 - 37.7" 71 - 96 cm | 29 - 38.9" 73.7 - 99 cm | 30 - 38" 84 - 109 cm |
| Trendelenburg Tilt | NA | ±10° | ±12° |
| Lateral Tilt | NA | NA | 12° |
| Longitudinal Tabletop Motion | 40" float 102 cm | 32" float 81 cm | 32" float 81 cm |
| Transverse Tabletop Motion | 10" float 25 cm | 8" float 20 cm | 8" float 20 cm |
| Standard Tabletop Size | 18/30" x 80" 46/76 x 203 cm | 24" x 84" 61 x 213 cm | 22"/24" x 84" 56/61 x 213 cm |
| Optional Tabletop Size | 23.5-30" x 80" 59-76 x 203 cm | NA | NA |
| Imaging Area | 72" 182.9 cm | 62" 157.5 cm | 61" 154.9 cm 73" with headrest attached (185.4 cm) |
| Patient Capacity | 450 lb. 204 kg | 450 lb. 204 kg | 450 lb. 204 kg |
| Table Weight | 490 lb. 222 kg | 605 lb. 274 kg | 605 lb. 274 kg |
| Tabletop Pad (2" thick) | ● | ● | ● |
| Restraint Straps | ● | ● | ● |
| Pendant Hand Control | NA | NA | ○ |
| 4-way Panning Hand Control | ● | ● | ● |
| Foot Control | ○ | ○ | ○ |
| Armboard, rail mounted | NA | ○ | ○ |
| Armboard, carbon fiber | ○ | ○ | ○ |
| VAB Armboard | ○ | ○ | ○ |
| Clamp-on Accessory Rail | NA | ○ | ○ |
| Catheter Tray extension | ○ | ○ | ○ |
| Headrest Extension | NA | NA | ○ |
| Table-Mounted Radiation Shield | ○ | ○ | ○ |

● = Standard Feature ○ = Optional NA = Not Available

ASPECT SERIES TABLE ACCESSORIES

Refer to Tables Specification & Accessory Matrix for table compatibility and to identify optional accessories and those that are included with specific table models.



Tabletop Extensions

| Catalog No. | Description | |
|-------------|---|--|
| A100-435 | ID410 Tabletop Width Extender Board, for 18" Top |  |
| A100-780 | ID410 Tabletop Width Extender Board, for 22" Top Lateral arms support, includes pads <ul style="list-style-type: none"> • Slides over head-end of table. • Carbon fiber • Provides additional width for 18", or 22" wide Aspect tabletops. | |
| A100-814 | Catheter Tray Extension for Aspect 100-4 Rail-attached catheter tray extension for Aspect 100-4 vascular table. Dimensions: L = 27", W = 30.5" (68.5 cm x 77.5 cm) |   |
| A100-1769 | Catheter Tray Extension for Aspect 100-4T and ISR Rail-attached catheter tray extension for Aspect 100-4T and ISR vascular tables. On ISR table this extension attaches to pedestal end of table only (24" wide end). Dimensions: L = 27" (68.5 cm), W = 24.4" (61.9 cm) | |
| A100-2322 | Catheter Tray Extension for Aspect ISR Rail-attached catheter tray extension for ISR vascular table. Attaches to narrow end of table only (22" wide end). Requires tabletop X100-2308. Dimensions: L = 27" (68.5 cm), W = 20.75" (52.7 cm) | |
| A100-2317 | Headrest Extension, Articulating For Aspect ISR table model only. Attaches to narrow end of table only (22" wide end). Requires tabletop X100-2322. Length = 12" (30.5 cm). |  |



Armboards and Rail-Mounted Accessories

| Catalog No. | Description | |
|-------------|--|---|
| A100-1007 | <p>Clamp-On Accessory Rail</p> <p>Clamps to Aspect Series carbon fiber tabletops to provide side-rail section for rail-mounted accessories. 3/8" x 1-1/8" rail.</p> <p>Compatible with Aspect 100, 100E, 100R, 100T, 100RT and 100RTL table models.</p> |  |
| A100-1770 | <p>Clamp-On Accessory Rail for Aspect 100-4T and ISR Table</p> <p>Clamps to carbon fiber tabletop. 3/8" x 1-1/8" rail.</p> | |
| A100-2218 | <p>Clamp-On Accessory Rail for 100UCPlus Tabletop Extension</p> <p>Clamps to carbon fiber tabletop extension. 3/8" x 1-1/8" rail.</p> | |
| C000-0746 | <p>Side-Rail Clamp, Rotating, with EZ Lock Handle</p> <p>With socket for attachment of anesthesia screen holders or other accessories with 5/8" circular post.</p> |  |
| A310-056 | <p>Armboard, Quick Release, rail-mounted</p> <p>Pivoting armboard. Not radiolucent. Includes pad and strap. Requires clamp-on accessory rail A100-1007 (above) for use on any IDI table where armboard is not mounted to built-in table side rail.</p> |  |
| A310-059 | <p>Armboard, carbon fiber, shoulder-mount, flat (shown at right without pad)</p> <p>Single, pivoting armboard with pad and strap. Attaches by sliding the thin support section under patient shoulder and table pad. Design permits two armboards to be used simultaneously.</p> |  |
| A100-2244 | <p>VAB Radiolucent Armboard</p> <p>(Ultra-sturdy and extra-wide, one-piece, carbon fiber armboard for vascular access and angiographic imaging of the arm. Attachment channel slides over opposite edge of tabletop to secure armboard to table. Armboard position may be rotated. Includes 2" thick pad & strap.</p> |  |

Table Accessories (continued)

| Catalog No. | Description |
|-------------|---|
| C000-0973 | <p>Anesthesia Screen Holder Rigid rod, single point mount. Adjusts vertically 22" to 30" (60 cm to 76 cm) and rotates horizontally. Requires a rotating side rail clamp C000-0746. If anesthesia screen is to be attached to tabletop area that has no side rail a clamp-on accessory rail is also required. (see Clamp-on Accessory Rails on pg. 16 to determine correct version for specific table model).</p>  |
| C000-0965 | <p>Anesthesia Screen Holder, Flexible Malleable "hoop" design. Requires pair of rotating side-rail clamp C000-0746. If anesthesia screen holder is to be attached to tabletop area that has no built-in side rail, a pair of clamp-on accessory rails are also required. (see Clamp-on Accessory Rails on pg. 16 to determine correct version for specific table model).</p>  |

Radiation Shields, Table Mounted

| Catalog No. | Description |
|-------------|---|
| A610-080 | <p>Radiation Shield, 24 x 24, includes table clamp For table models 100, 100E, 100R, 100T, 100RT & 100RTL. Clamps to carbon fiber tabletop. Snap-on upper section above level of tabletop is removable. Multiple units may be used in combination to increase shielded area.</p>  |
| A610-099 | <p>Radiation Shield, 24 x 24, includes table clamp. Same as A610-080 above but for <u>ISR and 100-4T table models only.</u></p> |
| A610-051 | <p>Radiation Shield, Articulating, Rail Mounted For Aspect 100-4, 100-4T and ISR vascular tables. Attaches to table side-rail at base end of table. Articulating joint allows shield to conform to table contour. Snap-on upper section above level of tabletop is removable.</p>  |

Radiation Shields, *continued*

| Catalog No. | Description |
|-------------|--|
| A610-096 | <p>Scatter-Guard Radiation Draping For Aspect 100 thru 100RTL table models with 24" rectangular tabletop. Dimensions: 59" long, 24" draping below tabletop. Draping extends along both sides and head-end of table. Supported by fabric section over tabletop.</p> |
| A610-092 | <p>Scatter-Guard Radiation Draping For Aspect 100 thru 100RTL table models with 22" tapered-end tabletop with facial cutout. Dimensions: 59" long, 24" draping below tabletop. Draping extends along both sides and head-end of table. Supported by fabric section over tabletop.</p> |



Facial Support and Spinal Imaging Accessories

| Catalog No. | Description |
|-------------|---|
| C000-0597 | <p>Facial Cushion, Crescent Shaped Soft, patient facial support cushion for pain management procedures & other patient prone positions. Can be used with tabletops that have or do not have built-in facial cutout.</p> |
| C000-0598 | <p>Disposable Covers for Crescent Shaped Facial Cushion Box of 50</p> |
| C000-0822 | <p>Spine Positioning System contains the components below.</p> <p>Package includes:</p> <ul style="list-style-type: none"> Frame with face rest (1): 12" x 33.5" (30 x 85 cm) Crescent face pad (1): 12" (30 cm) diameter Torso Support (1): 5.5" x 16" x 27" (14 x 30 x 58 cm) Torso Wedge (2): 2.5" x 16" x 23" (6 x 41 x 58 cm) Adjuster Pad (2): 1" x 7" x 12" (3 x 18 x 30 cm) Adjuster Pad (2): 1" x 8" x 16" (3 x 20 x 41 cm) 8" ½ Round Ankle Bolster: 2" x 8" x 26" (5 x 20 x 66 cm) 8" Semi-Round Ankle Bolster: 6" x 8" x 26" (15 x 20 x 66 cm) |

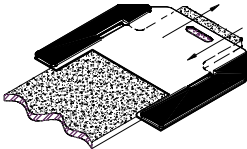

Straps and Replacement Armboard Pads

| Catalog No. | Description | |
|-------------|---|---|
| C000-0328 | Patient Restraint Straps, pair, one 3" wide and one 5" wide for all Aspect Series tables except Urology/Gyn models | |
| C000-0571 | Restraint Straps, pair, 3" wide, for Aspect Series Urology Tables | |
| C000-0455 | Armboard Strap Replacement strap for Armboards A310-056, A310-059 and A310-061 | |
| X100-1655 | Armboard Pad, ½" Replacement pad for Armboards A310-056 and A310-059 when used with 1" thick tabletop pad | |
| X100-1607 | Armboard Pad, 1.5" For armboard A310—056 and A310-059 when used with 2" thick tabletop pad | |
| C000-0709 | VAB Armboard Strap |  |
| X100-2243 | VAB Armboard Pad, 2" thick, for "straight" VAB Armboard A100-2244 | |
| X100-1786 | VAB Armboard Pad, 2' thick, for older-style "boomerang shape" VAB Armboard A100-1809 | |
| X100-1661 | Pad for ID410 Table Width Extender Board, 1", qty. 1 For use with 1" thick tabletop pad. (Extender board has 2 pads). |  |
| X100-1755 | Pad for ID410 Table Width Extender Board, 2", qty. 1 For use with 2" thick tabletop pad. (Extender board has 2 pads). | |

Urology Table Accessories: Leg Holders

| Catalog No. | Description | |
|-------------|---|--|
| C000-2246 | <p>Boot-Style Legholders, Pneumatic Assist (pair) Gas spring height adjustment. Includes pads. For patients up to 350 lbs. (159 kg). Includes pair of side rail clamps C000-0656 (see below).</p> |  |
| C000-0656 | <p>Replacement Side-Rail Clamp with Blade-Style Socket (qty. of 1) For Leg Holders C000-2246 and C000-2247.</p>  | |
| C000-2247 | <p>Heavy Duty Boot-Style Legholders, Pneumatic Assist (pair) Gas spring height adjustment. Includes pads. For patients over 350 lbs. (159 kg). Includes pair of side rail clamps C000-0656 (see above)</p> <p style="text-align: center;"><i>Shown at right with and without pad</i></p> |  |
| C000-2248 | <p>Basic Knee Crutches, (pair). Includes doughy soft pads for reduced popliteal pressure. One easy-to-use handle provides vertical adjustment and 360° horizontal rotation. For patients up to 400 lbs. (181 kg). Includes pair of side-rail clamps C000-0746 (See below).</p> |  <p style="text-align: center;"><i>Basic Knee Crutches are recommended for Aspect 100US table only. Not recommended for Aspect 100UC table model.</i></p> |
| C000-0746 | <p>Replacement Rotating Side-Rail Clamp (qty. of 1) for Basic Knee Crutches Easy to lock and rotate. (For use only with round post stirrup rods such as those on Basic Knee Crutches above).</p>  | |

Urology Table Accessories
Disposables and Replacement Items for Aspect 100U, 100UC & 100UC Plus

| Catalog No. | Description | |
|-------------|--|---|
| C000-0595 | Uro Drain Bag Support Hoop, collapsible |  |
| C000-0593 | Disposable Drain Bag and Hose Ass'y. box of 20 | |
| C000-0594 | Physician Elbow Supports (pair), with pads | |
| C000-0905 | Fluid Disposal Container, disposable, box of 10 Disposable fluid container for urological procedures. 10 liter capacity. Stop-cock system allows easy shut-off when changing containers. Spigot fits IDI drain bag hose without adapter. Container includes SteriGel™ encapsulating powder. |  |
| C000-0916 | Fluid Disposal Container, disposable, box of 10 Same as above but with 20 liter capacity. | |
| Z100-1060 | Removable Radiation Shield Drape Replacement lead drape for perineal end of IDI urology tables. 0.5mm Pb equivalency. |  |
| W100-1001 | Radiographic Cassette Tray, Aspect 100U & 100UC Tables (Former Cat. # Q100-1121) |  |
| C000-0492 | Disposable Covers for 100UC Footswitch 24" x 20", box of 50 | |
| C000-0645 | Disposable Tabletop Protector for Aspect Series Urology Tables Box of 20 | |

Table Hand Controls

| Catalog No. | Description |
|-------------|---|
| K000-0041 | Hand Control, for 100E, 100US, EZ-Access |
| K000-0054 | Hand Control, for 100R, 100T |
| K000-0195 | Hand Control, for 100RT |
| K000-0197 | Hand Control, for 100RTL |
| A270-126 | Hand Control, Panning, for 100-4 |
| A270-146 | Hand Control, Panning, for 100-4T |
| A270-0163 | Hand Control, Panning, for ISR |
| A100-2170 | Pendant Hand Control, for ISR |
| K000-0112 | Hand Control, for 100U |
| K000-0158 | Hand Control, for 100UC |

Table Footswitch Controls





| | | |
|-----------|--|---|
| A100-1540 | Footswitch Control, for 100UC & 100UC Plus Circular center pedal controls 4-way tabletop motion. Outer rocker pedals control table elevate and tilt. |  |
| A100-758 | Footswitch Control, for 100E, 100US, EZ-Access |  |
| A100-1823 | Footswitch Control for Aspect High-Tilt model | (2 button; same style as footswitch above) |
| A100-500 | Footswitch Control, for 100R, 100T, 100EP |  |
| A100-1960 | Footswitch Control, for 100RT | (6 button; same style as 100RTL footswitch below) |
| A100-1961 | Footswitch Control, for 100RTL |  |
| A100-1533 | Footswitch Control, for 100U | (6 button; same style as 100RTL footswitch above) |
| A100-1816 | Footswitch Control, 100-4T |  |

Table Footswitch Controls (continued)

| Catalog No. | Description |
|-------------|--|
| A100-659 | Footswitch Control, for 100-4, 100FC, 100C  |
| A100-2071 | Footswitch Control, ISR  |

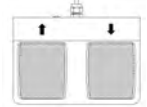
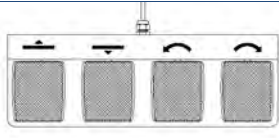
MDS Mobile Video Display System Catalog No. A280-0330

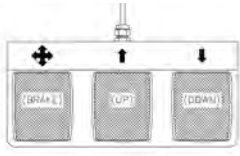
MDS Mobile Display System, complete with High Definition Video Monitors and Video Router/Controller. System includes:

- Dual-Arm Mobile Display Stand
- Radiance 26" High-Brightness LCD Widescreen Multi-Modality Video Monitors (Qty of 2).
- ConductOR Video Router/Controller with Touchscreen User Interface
- Dual 8" (20cm) "Preview" LCD Reference Monitors, mounted to MDS stand center column.
- Protective covers for 26" Radiance monitors (Qty of 2).
- Video Cable kit, including common cables/connectors needed for connection of C-arm and other equipment that will be connected to MDS Mobile Display System.



SPECIFICATIONS:

Dual Arm Mobile Display Stand

The Aspect MDS stand provides a wide-range of vertical and horizontal positioning for convenient placement of video monitors at the desired location during surgical, interventional and diagnostic procedures. The stand includes three (3) equipment shelves for placement of ancillary equipment such as video endoscopy camera control, light source, etc.

- Dual articulating monitor arms with positioning handles and low-force manual motion for easy video monitor positioning.
- Monitor arms provide 36" of fully counter-balanced vertical travel and arm radius extends horizontally up to approx. 76" (193cm) with vertical height up to 96" (244 cm).
- Cable track allows vertical height adjustment of arms without cabling stress.
- Built-in, adjustable equipment racks, 19.75" (50 cm) wide x 16" (40.6 cm) depth, qty. of three (3).
- Lockable double-wheeled 6" casters with cable pushers and rear casters include steering lock position for easy transport.
- Ergonomic transport handles, front and rear, for easy transport and positioning.
- Built-in storage compartment for monitor protective covers

MDS Mobile Display System Specifications *(continued)*

- Built-in isolation transformer and AC power strip for connection of video components and up to 5 outlets for ancillary equipment that may be mounted to MDS shelves.

AC Input Power Options

North America Version: For connection to 110-120VAC, 60 Hz, 15 amp outlet. Includes built-in 1,800 Watt isolation transformer and 15 amp power cord and hospital grade plug. Maximum allowable combined load on MDS power strip = 12 amps.

EU Version. For connection to 220-240 VAC, 50 Hz, ~10 amp outlet (must specify country plug type). Includes 1800 Watt isolation transformer, power cord and plug. Maximum allowable combined load on MDS power strip = 7.5 amps.

26" Radiance® G2 HB (High-Brightness) LCD Widescreen High-Definition Video Monitors

LED backlight technology for very high brightness. Full multi-modality with multiple inputs. Switchable source video display and single image, picture-in-picture, or split-screen mode. Resolution: 1920 x 1080. Aspect ratio: 16:9. Brightness: 700 cd/m² (typical). Picture size: 22.7" x 12.7" (576 x 324 mm).

ConductOR™ G2 Video Router/Controller

Medical imaging video router with touch-screen operator control. Allows any input to be routed to either monitor and allows any two inputs to be displayed at monitor in picture-in-picture or split screen format. Allows various inputs to be used without hardware changes to monitor connections:

- Unit is configured with 8 video input connections to include:
 - o DVI-D (3)
 - o 3G-SDI (1)
 - o S-Video (1)
 - o Component (1)
 - o VGA/SOG (1)
 - o DVI-I/RGBS/YPbPr (1)
- Unit is configured with 3 video output connections to include:
 - o 3G-SDI (2) - these are used for connection to system monitors
 - o DVI-D (1) - for connection of external device such as printer, DVR, etc.

Size: 14" W x 5.2" W x 15.5" D (394 x 46 x 391 mm)

Dual, 8" "Preview" LCD Reference Monitors

The Preview monitors are mounted to the MDS stand center column above the top shelf for easy visualization of video routing while operating the ConductOR touchscreen control. The left and right Preview monitors serve as visual reference only - to display what is displayed on the left and right 26" monitors that are mounted to the MDS articulating arms.

Padded, Protective Covers for 26" Radiance Monitors

Foam padded construction for monitor glass protection during transport and storage. Cleanable fabric cover material with Velcro straps for easy cover attachment and removal.

Mobile C-arm Cable Connector Kit:

Choice of one cable kit for connection to GE OEC, Philips, Siemens or Ziehm mobile C-arm. Must specify with order. Contact IDI regarding purchase of additional cable kits.

MDS Replacement Accessories & Cable Kits

Certain cable kits and accessories are included with the MDS System. Cable kits and accessories listed below are for orders for replacement items or additional cable kits.

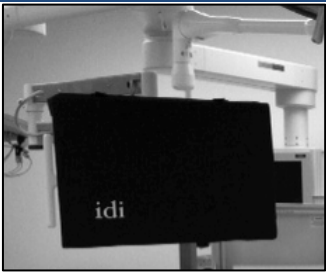
| Catalog No. | Description | |
|-------------|--|---|
| | Cable Kits for connection of C-arm and Endoscopy Systems: <i>Customer choice of one of the following cable kits is included with MDS Complete System A280-0330 at no extra charge. Customer must specify the one selected cable kit with MDS System order. Cable kits shown below apply only to orders for replacement or additional cable kits.</i> | |
| A280-0325 | Cable kit for GE OEC C-arm: Video connection kit including qty. (2) 6 ft. internal SVGA HD15 to BNC RGBS (SOG) connector cable; qty. (1) dual BNC connector panel; qty. (1) DVI-I/SVGA HD15 adapter; and qty. (2) external 15 ft. BNC 75 ohm coaxial cable (1) Endo Cable Kit (1-BNC SDI 5 ft.; 1-DVI-I 3 ft.; 1-SVGA HD15 3 ft., 1-S Video 3 ft.). NOTE: This kit also compatible with Ziehm or Philips C-arms if using BNC coax analog video output. | |
| A280-0327 | Cable kit for Philips C-arm: Video connection kit including qty. (2) internal DVI-I to DVI-I 5 ft. cable; qty. (1) dual DVI-I connector panel; and qty. (2) external 10 ft. DVI cable, and Endo Cable Kit (1-BNC SDI 5 ft.; 1-DVI-I 3 ft.; 1-SVGA HD15 3 ft., 1-S Video 3 ft.). | |
| A280-0326 | Cable kit for Siemens C-arm: Video connection kit including qty. (2) internal SVGA to SVGA 5 ft. internal cables; qty. (1) dual SVGA connector panel; qty. (1) DVI-I/SVGA HD15 adapter; and qty. (2) external 20 ft. external VGA cable and Endo Cable Kit (1-BNC SDI 5 ft.; 1-DVI-I 3 ft.; 1-SVGA HD15 3 ft., 1-S Video 3 ft.). | |
| A280-0328 | Cable kit for Ziehm C-arm: Video connection kit including internal qty. (2) DVI to DVI 5 ft. internal cables, qty. (1) dual DVI connector panel and qty. (2) external 10 ft. DVI cable and Endo Cable Kit (1-BNC SDI 5 ft.; 1-DVI-I 3 ft.; 1-SVGA HD15 3 ft., 1-S Video 3 ft.). NOTE: if using BNC coax video outputs, use kit #A280-0325, above. | |
| A280-0331 | Cable Kit for Endoscopy system connection: Includes 1-BNC 75 ohm SDI 5ft., 1- DVI-I 3 ft., 1 SVGA HD15 3 ft., 1 S Video 3ft. <i>(this kit is also included with C-arm cable kits above)</i> | |
| | MDS Accessories: | |
| Q280-0272 | Monitor Protection Cover for 26" flat panel monitor. Padded fabric cover with velcro attachment straps. <i>(2 covers are included with MDS System A280-0330).</i> |  |
| C000-0709 | Monitor handle security strap, velcro. <i>(1 strap is included with MDS System A280-0330)</i> | |
| P280-0130 | MDS shelf 19.75" wide x 16" depth (50cm x 40.6 cm). <i>(3 shelves are included with MDS System A280-0330).</i> | |

For IDI product support and customer service:

Phone **978-829-0009**
Fax **978-829-0027**
Toll Free **877-304-5434**
Email: **sales@imagediagnostics.com**

NOTES: