

# Aspect™ Series Imaging Tables & Accessories Catalog

Quality products for surgical, interventional and diagnostic imaging



Image Diagnostics, Inc.  
310 Authority Drive  
Fitchburg, MA 01420

[www.imagediagnostics.com](http://www.imagediagnostics.com)

October 2010 D000-495M

**idi**  
Image Diagnostics, Inc.  
*Safety, Simplicity, Quality*

## CONTENTS

<b>Aspect Series Tables</b>	
Key Features	3
Applications Selection Chart	3
Tabletop Selections	4
Pain Management and Multi-Purpose Tables	5-7
Vascular and Interventional Tables, with 4-way Floating Tops	8
Swallow Studies – Upright Tilting Table	9
Electrophysiology Table	10
Digital Radiography & General Imaging Tables	10
Urology and Gynecology Tables	11-12
<b>Table Specification and Accessory Matrix</b>	
Pain Management, General and Vascular Imaging Tables	13
<b>Table Accessories - General</b>	
Tabletop Extensions	14
Armboards and Rail-Mounted Accessories	14-15
Radiation Shields, Table Mounted	16
Facial Support and Spinal Imaging Accessories	17
Straps and Replacement Armboard Pads	18
<b>Urology Table Accessories</b>	19-20
<b>Replacement Tabletop Pads</b>	21
<b>Hand &amp; Footswitch Controls</b>	22

IDI Aspect Series Tables are ETL Listed (IEC, UL & CSA Standards) and CE marked.  
 Technical Specifications are subject to change without notice.

### Aspect Series Tables... C-arm Imaging At Its Best

All Aspect Series tables with cantilevered tabletops are designed to provide these advantages...

- Long, slim-profile wheel base for...
  - Excellent stability and safety
  - Unencumbered C-arm access
  - Very low table weight for easy maneuverability and transport
- Small base pedestal and very large, unencumbered imaging areas: 59 – 72 inches (150 – 183cm), depending on model
- High-quality, carbon fiber tops for excellent fluoroscopic imaging with minimal x-ray attenuation
- Highest quality mechanical components for exceptional durability and reliability.
- Sleek, easy-to-clean base and covers
- Multiple table top styles for optimal design and performance based on customer clinical requirements
- A common platform for a wide range of motorized and manual movements
  - Application-specific designs, *the right price-performance solution for every customer*



- ✓ Superior C-arm access
- ✓ Exceptional stability & safety
- ✓ Both low table weight and...
- ✓ High patient weight capacity
- ✓ Durable and easy-to-clean design



### Aspect Series Imaging Tables Application Selection Chart

Model	Pain Mgmt.	Ortho & General	Vascular & Interventional	Swallow Studies	Urology & GYN	Electro-physiology	Digital Radiography
<b>100 &amp; 100E</b>	●	●					
<b>100R/100T</b>	●	●					
<b>100RT</b>	●	●					
<b>100RTL</b>	●	●	●				
<b>100-4</b>			●				○
<b>100-4T</b>			●				○
<b>100EP</b>						●	
<b>HIGH-TILT</b>				●			
<b>100UCPlus</b>	○	○			●		
<b>100US</b>					Gyn		
<b>100C &amp; FC</b>							●

## Tabletop Selections for Aspect Mobile Imaging Tables

All Aspect Series Tabletops feature very low attenuation, carbon fiber construction. Standard tops may be substituted with optional sizes/styles as shown below at no extra charge.

Aspect 100, 100E, 100T, 100R, 100RT and 100RTL Tabletops



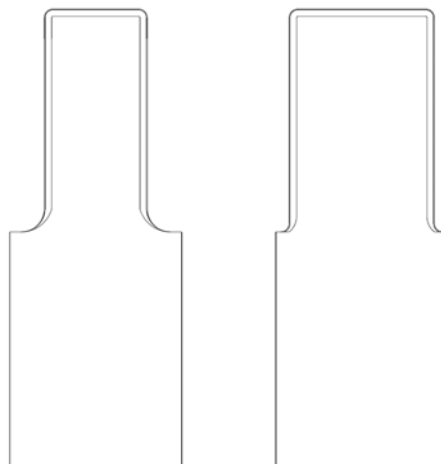

Standard	Optional
X100-995	X100-733
24" x 80" 61 x 203cm	22" x 80" 56 x 203cm <i>with facial cutout</i>

Aspect 100-4 Tabletops





Standard	Optional
X100-517	X100-982
18" - 30" W x 80" L 45.7 - 76.2 x 203cm	23.5" - 30" W x 80" L 59.4 - 76.2 x 203cm

## Tables for Pain Management and General C-arm Imaging Applications

Catalog No.	Model & Description	Specifications
A100-203	<p><b>Aspect 100</b> Fluoroscopic Procedure Table, Fixed Height</p> 	<ul style="list-style-type: none"> <li>Carbon fiber tabletop with low x-ray attenuation</li> <li>Tabletop: 24" x 80" (61 x 203 cm)</li> <li>Optional Tabletop: 22" x 80" (56 x 203 cm) with facial cutout</li> <li>66" (167.6 cm) unobstructed imaging area</li> <li>37" (94 cm) tabletop height (tabletop to floor) <ul style="list-style-type: none"> <li>Customer may specify different height at time of order</li> </ul> </li> <li>Locking swivel casters</li> <li>450 lb. (204 kg) patient weight capacity</li> <li>Table weight = 250 lbs. (113 kg)</li> </ul> <p><b>Accessories included:</b></p> <ul style="list-style-type: none"> <li>Tabletop Pad, 2" thick</li> </ul>
A100-402	<p><b>Aspect 100E</b> Fluoroscopic Procedure Table with Motorized Elevation</p> 	<ul style="list-style-type: none"> <li>Carbon fiber tabletop with low x-ray attenuation</li> <li>Tabletop: 24" x 80" (61 x 203 cm)</li> <li>Optional Tabletop: 22" x 80" (56 x 203 cm) with facial cutout</li> <li>66" (167.6 cm) unobstructed imaging area</li> <li>Motorized tabletop elevation 26" – 37.8" (66 – 96 cm) with hand control</li> <li>Locking swivel casters</li> <li>450 lb. (204 kg) patient weight capacity</li> <li>Table weight = 350 lbs. (158 kg)</li> <li>120 VAC operation (230 VAC optional)</li> <li>Battery back-up operation</li> </ul> <p><b>Accessories included:</b></p> <ul style="list-style-type: none"> <li>Tabletop Pad, 2" thick</li> <li>Patient Restraint Straps</li> <li>Facial cushion, crescent shape</li> <li>Disposable covers for facial cushion, box of 50</li> </ul>
A100-658	<p><b>Aspect 100T</b> Fluoroscopic Procedure Table, with Motorized Elevation and Trendelenburg Tilt</p> 	<ul style="list-style-type: none"> <li>Carbon fiber tabletop with low x-ray attenuation</li> <li>Tabletop: 24" x 80" (61 x 203 cm)</li> <li>Optional Tabletop: 22" x 80" (56 x 203 cm) with facial cutout</li> <li>62" (157.5 cm) unobstructed imaging area</li> <li>Motorized tabletop movements with hand control <ul style="list-style-type: none"> <li>Elevation 28" – 39.8" (71 – 101 cm)</li> <li>Trendelenburg Tilt <math>\pm 15^\circ</math></li> </ul> </li> <li>Locking swivel casters</li> <li>450 lb. (204 kg) patient weight capacity</li> <li>Table weight = 350 lbs. (158 kg)</li> <li>120 VAC operation (230 VAC optional)</li> <li>Battery back-up operation</li> </ul> <p><b>Accessories included:</b></p> <ul style="list-style-type: none"> <li>Tabletop Pad, 2" thick</li> <li>Patient Restraint Straps</li> <li>Facial cushion, crescent shape</li> <li>Disposable covers for facial cushion, box of 50</li> </ul>



## Tables for Pain Management and General C-arm Imaging Applications (continued)

Catalog No.	Model & Description	Specifications
A100-662	<p><b>Aspect 100R</b> Fluoroscopic Procedure Table, with Motorized Elevation and Lateral Roll</p> 	<ul style="list-style-type: none"> <li>• Carbon fiber tabletop with low x-ray attenuation</li> <li>• Tabletop: 24" x 80" (61 x 203 cm)</li> <li>• Optional Tabletop: 22" x 80" (56 x 203 cm) with facial cutout</li> <li>• 62" (157.5 cm) unobstructed imaging area</li> <li>• Motorized tabletop movements with hand control               <ul style="list-style-type: none"> <li>- Elevation 28.5" – 40" (72 – 102 cm)</li> <li>- Lateral Roll <math>\pm 20^\circ</math></li> </ul> </li> <li>• Locking swivel casters</li> <li>• 450 lb. (204 kg) patient weight capacity</li> <li>• Table weight = 395 lbs. (179 kg)</li> <li>• 120 VAC operation (230 VAC optional)</li> <li>• Battery back-up operation</li> </ul> <p><b>Accessories included:</b></p> <ul style="list-style-type: none"> <li>• Tabletop Pad, 2" thick</li> <li>• Patient Restraint Straps</li> <li>• Facial cushion, crescent shape</li> <li>• Disposable covers for facial cushion, box of 50</li> </ul>
A100-870	<p><b>Aspect 100RT</b> Fluoroscopic Procedure Table, with Motorized Elevation, Trendelenburg Tilt and Lateral Roll</p> 	<ul style="list-style-type: none"> <li>• Carbon fiber tabletop with low x-ray attenuation</li> <li>• Tabletop: 24" x 80" (61 x 203 cm)</li> <li>• Optional Tabletop: 22" x 80" (56 x 203 cm) with facial cutout</li> <li>• 62" (157.5 cm) unobstructed imaging area</li> <li>• Motorized table movements with hand control               <ul style="list-style-type: none"> <li>- Elevation 30.4" – 42.2" (77 – 107 cm)</li> <li>- Trendelenburg Tilt <math>\pm 15^\circ</math></li> <li>- Lateral Roll <math>\pm 20^\circ</math></li> <li>- Auto return-to-level button and positional memory</li> </ul> </li> <li>• Locking swivel casters</li> <li>• 450 lb. (204 kg) patient weight capacity</li> <li>• Table weight = 425 lbs. (193 kg)</li> <li>• 120 VAC operation (230 VAC optional)</li> <li>• Battery back-up operation</li> </ul> <p><b>Accessories included:</b></p> <ul style="list-style-type: none"> <li>• Tabletop Pad, 2" thick</li> <li>• Patient Restraint Straps</li> <li>• Facial pad, crescent shape</li> <li>• Disposable covers for facial pad, box of 50</li> </ul>

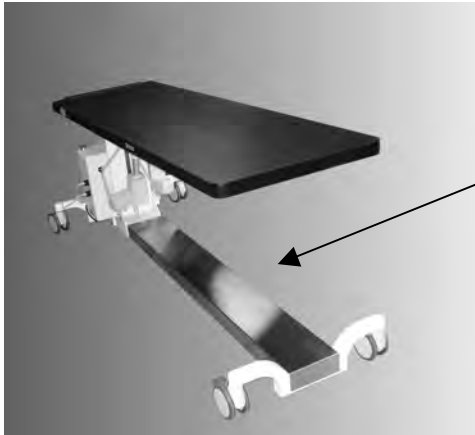
### Tables for General C-arm Imaging Applications (continued)

Catalog No.	Model & Description	Specifications
<p>A100-1254</p>	<p><b>Aspect 100RTL</b> Fluoroscopic Procedure Table, with Motorized Elevation, Trendelenburg Tilt, Lateral Roll and Longitudinal Tabletop Motion</p> 	<ul style="list-style-type: none"> <li>• Carbon fiber tabletop with low x-ray attenuation</li> <li>• Tabletop: 24" x 80" (61 x 203 cm)</li> <li>• Optional Tabletop: 22" x 80" (56 x 203 cm) with facial cutout</li> <li>• 59" (150 cm) unobstructed imaging area</li> <li>• Motorized table movements with hand control               <ul style="list-style-type: none"> <li>- Elevation 31.2" – 41.2" (79 – 104.6 cm)</li> <li>- Trendelenburg Tilt <math>\pm 15^\circ</math></li> <li>- Lateral Roll <math>\pm 20^\circ</math></li> <li>- Longitudinal tabletop travel = 10" (25.4 cm)</li> <li>- Auto return-to-level button and positional memory</li> </ul> </li> <li>• Locking swivel casters</li> <li>• 450 lb. (204 kg) patient weight capacity</li> <li>• Table weight = 460 lbs. (209 kg)</li> <li>• 120 VAC operation (230 VAC optional)</li> <li>• Battery back-up operation</li> </ul> <p><b>Accessories included:</b></p> <ul style="list-style-type: none"> <li>• Tabletop Pad, 2' thick</li> <li>• Patient Restraint Straps</li> <li>• Facial cushion, crescent shape</li> <li>• Disposable covers for facial cushion, box of 50</li> </ul>
<p>Z100-1628</p> <p>Z100-1629</p>	<p>Stainless Steel Base Cover Option for 100E, 100T, 100R, 100RT</p> <p>Stainless Steel Base Cover Option for 100-4 &amp; 100RTL</p> 	<p>Optional stainless steel base cover. Must specify at time of table order.</p>

## Tables for Vascular & Interventional Imaging Applications

Catalog No.	Model & Description	Specifications
A100-566	<p><b>Aspect 100-4</b> Fluoroscopic Procedure Table with 4-way Manual Floating Tabletop and Motorized Elevation</p> 	<ul style="list-style-type: none"> <li>• Carbon fiber tabletop with low x-ray attenuation</li> <li>• Tabletop = 18" / 30" x 80" (46 / 76 x 203 cm)</li> <li>• Optional tabletop: 23.5" / 30" x 80 (59/72 x 203 cm)</li> <li>• 72" (182.9 cm) unobstructed imaging area</li> <li>• Motorized Elevation 27.9" – 37.7" (71 – 95.8 cm)</li> <li>• 4-way manual floating tabletop with panning hand control               <ul style="list-style-type: none"> <li>- Longitudinal tabletop float 40" (101.6 cm)</li> <li>- Transverse tabletop float 10" (25.4 cm)</li> </ul> </li> <li>• Locking swivel casters</li> <li>• 450 lb. (204 kg) patient weight capacity</li> <li>• Table weight = 490 lbs. (222 kg)</li> <li>• 120 VAC operation (230 VAC optional)</li> <li>• Battery back-up operation</li> </ul> <p><b>Accessories included:</b></p> <ul style="list-style-type: none"> <li>• Tabletop Pad &amp; Patient Restraint Straps</li> <li>• ID410 Width Extender Board (lateral arms support, for 18" wide top only)</li> </ul>
A100-1416	<p><b>Aspect 100-4T</b> Fluoroscopic Procedure Table with 4-way Manual Floating Tabletop, Motorized Elevation and Trendelenburg Tilt</p>  	<ul style="list-style-type: none"> <li>• Carbon fiber tabletop with low x-ray attenuation</li> <li>• Tabletop = 24" x 84" (61 x 213.4 cm)</li> <li>• 62" (157.5 cm) unobstructed imaging area</li> <li>• Motorized Elevation 29" – 38.9" (73.7 – 98.8 cm)</li> <li>• Trendelenburg Tilt <math>\pm 10^\circ</math> with auto return-to-level function</li> <li>• 4-way manual floating tabletop with panning hand control               <ul style="list-style-type: none"> <li>- Longitudinal tabletop float 32" (81.3 cm)</li> <li>- Transverse tabletop float 8" (20.3 cm)</li> </ul> </li> <li>• 4-way float locked unless panning hand control is depressed and table is level</li> <li>• 5" swivel rear casters with electrical locking</li> <li>• 3" swivel dual front casters</li> <li>• 450 lb. (204 kg) patient weight capacity</li> <li>• Table weight = 605 lbs. (274 kg)</li> <li>• 120 VAC operation (230 VAC optional)</li> <li>• Battery back-up operation</li> </ul> <p><b>Accessories included:</b></p> <ul style="list-style-type: none"> <li>• Tabletop Pad (2" thick) &amp; Patient Restraint Straps</li> </ul> <p><b>Optional Accessories:</b></p> <ul style="list-style-type: none"> <li>• Footswitch control available for elevate, tilt, and 4-way float lock-release functions</li> <li>• Rail-mounted radiation shield</li> <li>• Radiolucent and standard armboards (see "Armboards" section, page 15).</li> </ul>

## Table for Swallow Studies and Upright Imaging/Patient Loading

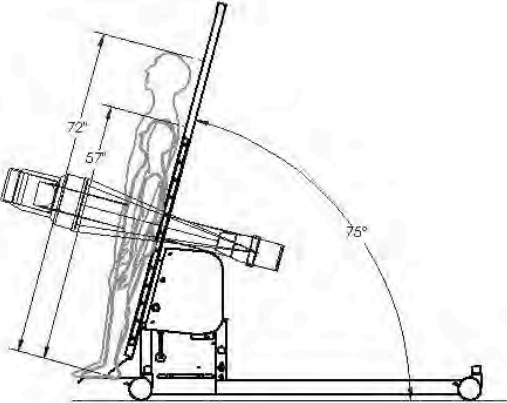
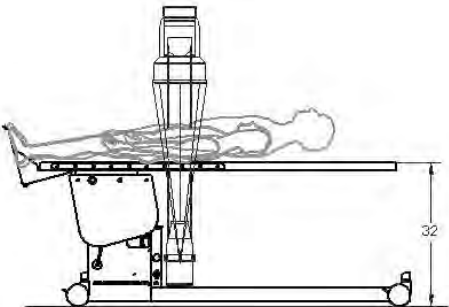
<p>A100-1708</p>	<p><b>Aspect 100HT High-Tilt™ Fluoroscopic Procedure Table</b></p>  <p><i>Ideal Imaging Solution for:</i></p> <ul style="list-style-type: none"> <li>➤ <b>Swallowing studies for post-surgical gastric banding adjustment</b></li> <li>➤ <b>Other C-arm procedures requiring upright patient imaging or loading</b></li> </ul> <ul style="list-style-type: none"> <li>• Motorized tilt from horizontal to 75° upright with footswitch operator control</li> <li>• Tilt speed ≈ 4°/sec. (≈ 20 seconds to full stroke)</li> <li>• Built-in footboard for “step-on” patient loading with table in upright position</li> <li>• 525 lb. (238 kg) patient weight capacity</li> <li>• Ultra-stable during tilt motion and in any table position</li> <li>• Easy C-arm imaging access in any tabletop position</li> <li>• Carbon fiber tabletop: artifact-free, low x-ray attenuation</li> <li>• Fixed tabletop height in horizontal position: 32" (81.3 cm)</li> <li>• Footboard position with table upright: 5" (12.7 cm) above floor</li> <li>• Tabletop size: 24"W x 80"L (61cm x 203cm)</li> <li>• Imaging area: 58" (147.3cm)</li> <li>• Standard US siderails (3/8" x 1 1/8") for handgrips attachment</li> <li>• Standard 110 volt operation with battery back-up</li> <li>• 5", locking casters and lightweight table for easy transport</li> <li>• Accessories included:             <ul style="list-style-type: none"> <li>• tabletop pad, 1" (2" thick pad optional)</li> <li>• patient handgrips</li> <li>• restraint straps</li> <li>• footswitch control</li> </ul> </li> </ul>  
------------------	---------------------------------------------------------------------------------------------------------------------------------------------------------------------------------------------------------------------------------------------------------------------------------------------------------------------------------------------------------------------------------------------------------------------------------------------------------------------------------------------------------------------------------------------------------------------------------------------------------------------------------------------------------------------------------------------------------------------------------------------------------------------------------------------------------------------------------------------------------------------------------------------------------------------------------------------------------------------------------------------------------------------------------------------------------------------------------------------------------------------------------------------------------------------------------------------------------------------------------------------------------------------------------------------------------------------------------------------------------------------------------------------------------------------------------------------------------------------------------------------------------------------------------------------------------------------------------------------------------------------------------------------------------------------------------------------------------------------------------------------------------------------------------------------------------------------------------------------------



## Electrophysiology Table

A100-831	<p><b>Aspect 100EP</b> Fluoroscopic Procedure Table for Electrophysiology</p> 	<ul style="list-style-type: none"> <li>• Carbon fiber tabletop with low x-ray attenuation</li> <li>• Tabletop = 22" x 84" (56 x 213.4 cm)</li> <li>• 61" (154.9 cm) unobstructed imaging area</li> <li>• Motorized table movements with footswitch control             <ul style="list-style-type: none"> <li>- Elevation 29" – 38.9" (73.7 – 98.8 cm)</li> <li>- Table Tilt 75°/15°</li> </ul> </li> <li>• Locking swivel casters</li> <li>• 350 lb. (158.8 kg) patient weight capacity</li> <li>• Table weight = 475 lbs. (215 kg)</li> <li>• 120 VAC operation (230 VAC optional)</li> <li>• Battery back-up operation</li> <li>• <b>Accessories included:</b> <ul style="list-style-type: none"> <li>• Tabletop Pad (1") &amp; Patient Restraint Straps</li> <li>• Footboard &amp; patient handgrips</li> </ul> </li> </ul>
----------	-----------------------------------------------------------------------------------------------------------------------------------------------------------------	---------------------------------------------------------------------------------------------------------------------------------------------------------------------------------------------------------------------------------------------------------------------------------------------------------------------------------------------------------------------------------------------------------------------------------------------------------------------------------------------------------------------------------------------------------------------------------------------------------------------------------------------------------------------------------------------------------------------------------------------------------------------------------------------------------------------------------

## Tables for Digital Radiography & General Imaging

A100-488	<p><b>Aspect 100FC</b> Floor-Mounted Imaging Table with Motorized Elevation and Manual Cross-table Float</p> 	<ul style="list-style-type: none"> <li>• Carbon fiber tabletop with low x-ray attenuation</li> <li>• Tabletop dimensions = 24" x 84" (61 x 213 cm)</li> <li>• Tabletop Pad included</li> <li>• 68" (172 cm) unobstructed imaging area</li> <li>• Motorized tabletop elevation 24" – 34" (61 – 86 cm) with footswitch control</li> <li>• 10" (25.4 cm) tabletop manual float cross-travel</li> <li>• Fixed Base, floor mounted.</li> <li>• 450 lb. (204 kg) patient weight capacity</li> <li>• Table weight ~ 385 lbs. (174.6 kg)</li> <li>• 120 VAC operation (230 VAC optional)</li> </ul>
A100-850	<p><b>Aspect 100C</b> Mobile Imaging Table with Motorized Elevation and Manual Cross-table Float</p> 	<ul style="list-style-type: none"> <li>• Carbon fiber tabletop with low x-ray attenuation</li> <li>• Tabletop dimensions = 24" x 80" (61 x 203 cm)</li> <li>• Tabletop Pad included</li> <li>• 64" (cm) unobstructed imaging area</li> <li>• Motorized tabletop elevation 27" – 39" (68.5 – 99 cm) with footswitch control</li> <li>• 10" (25.4 cm) tabletop manual float cross-travel</li> <li>• Locking, swivel casters</li> <li>• 450 lb. (204 kg) patient weight capacity</li> <li>• Table weight ~ 330 lbs. (150 kg)</li> <li>• 120 VAC operation (230 VAC optional)</li> </ul>

## Urology Table

Catalog No.	Model & Description	Specifications
A100-1517	<p><b>Aspect 100UC Plus</b> Urological Imaging Table, with Motorized Elevation, Trendelenburg Tilt, Longitudinal and Transverse Tabletop Motions</p>  <p><i>Leg-holders are not included and must be ordered separately. See "Urology Table Accessories", pg. 17. May also use any leg-holders with standard US table side-rail attachment.</i></p>  <p><i>Table with extension attached.</i></p>	<ul style="list-style-type: none"> <li>• Carbon fiber tabletop with low x-ray attenuation</li> <li>• Motorized Tabletop motions with hand control and footswitch control: <ul style="list-style-type: none"> <li>- Elevation: 31.27" – 41.1" (79.4 – 104.4 cm)</li> <li>- Trendelenburg Tilt: <math>\pm 15^\circ</math></li> <li>- Longitudinal tabletop travel: 10" (25.4 cm)</li> <li>- Transverse tabletop travel: 7" (17.8 cm)</li> </ul> </li> <li>• Tabletop = 28"W x 46"L ( 71 x 117 cm)</li> <li>• Radiolucent tabletop extension, 34" L x 24" W (86 x 61 cm)</li> <li>• 20"L x 25"W (51 x 63.5 cm) imaging area for endourology</li> <li>• 34"L x 24"W (86.4 x 61 cm) imaging area on extension</li> <li>• Total length of radiolucent imaging area with extension attached: 54" (137 cm)</li> <li>• Radiographic cassette tray, loads from either side of table</li> <li>• 5" (12.7 cm) locking swivel casters</li> <li>• Patient weight capacity: <ul style="list-style-type: none"> <li>- 525 lb. (238 kg) in endourology position with patient upper body over main tabletop section.</li> <li>- 400 lbs. (181 kg) with patient upper body on tabletop extension</li> </ul> </li> <li>• Table weight <math>\approx</math> 575 lbs. (<math>\approx</math>261 kg)</li> <li>• 120 VAC operation (230 VAC optional)</li> <li>• Battery back-up operation</li> <li>• Built-in footswitch storage tray</li> </ul> <p><b>Accessories included:</b></p> <ul style="list-style-type: none"> <li>• Tabletop pad, 2" thick with waterproof cover</li> <li>• Radiolucent tabletop extension with 2" pad</li> <li>• Hand control pendant</li> <li>• Footswitch control</li> <li>• Collapsible and removable drain bag hoop</li> <li>• Disposable drain bag and hose ass'y, box of 20</li> <li>• Removable Radiation Shield Flap for perineal end of table</li> <li>• Patient Restraint Straps</li> <li>• Armboards (1), rail mounted, with pad and strap</li> <li>• Disposable covers for footswitch and radiation shield flap, box of 50</li> </ul>

## Gynecology / Fertility Clinic Table

Catalog No.	Model & Description	Specifications
A100-1479	<p><b>Aspect 100US</b> GYN/Fertility Clinic Mobile Imaging Table, with Motorized Elevation</p>  <p><i>Lithotomy Leg-holders are not included and must be ordered separately. See Urology Table Accessories, pg. 19. May also use any leg-holders with standard US table side-rail attachment.</i></p>	<ul style="list-style-type: none"> <li>• Carbon fiber tabletop with low x-ray attenuation</li> <li>• Tabletop = 24" x 46" (61 x 117 cm)</li> <li>• 24" W x 32"L (61 x 81 cm) unobstructed imaging area</li> <li>• Motorized tabletop elevation with foot control: <ul style="list-style-type: none"> <li>- Elevation 26" – 38" (66 – 96.5 cm)</li> </ul> </li> <li>• Locking swivel casters</li> <li>• 450 lb. (204 kg) patient weight capacity</li> <li>• Table weight ≈ 395 lbs. (≈179 kg)</li> <li>• 120 VAC Operation (230VAC optional)</li> <li>• Battery back-up operation</li> <li>• <b>Accessories included:</b> <ul style="list-style-type: none"> <li>• Tabletop Pad, 1"</li> <li>• Patient Restraint Straps</li> </ul> </li> </ul>

## Aspect Series Tables Specifications & Accessory Matrices

### Pain Management, Vascular and General Imaging Tables



	100	100E	100R	100T	100RT	100RTL	100-4	100-4T
Elevate (tabletop to floor)	Fixed	26 - 37.8" 66 - 96 cm	28.5 - 40.3" 72 - 102 cm	28 - 39.8" 71 - 101 cm	30.4 - 42.2" 77 - 107 cm	31.2 - 41.2" 79 - 105 cm	27.9 - 37.7" 71 - 96 cm	29 - 38.9" 73.7 - 99 cm
Trendelenburg Tilt	NA	NA	NA	±15°	±15°	±15°	NA	±10°
Lateral Tilt	NA	NA	20°	NA	20°	20°	NA	NA
Longitudinal Tabletop Motion	NA	NA	NA	NA	NA	10" 25 cm	40" float 102 cm	32" float 81 cm
Transverse Tabletop Motion	NA	NA	NA	NA	NA	NA	10" float 25 cm	8" float 20 cm
Standard Tabletop Size	24" x 80" 61 x 203cm	24" x 80" 61 x 203 cm	24" x 80" 61 x 203 cm	24" x 80" 61 x 203 cm	24" x 80" 61 x 203 cm	24" x 80" 61 x 203 cm	18 -30" x 80" 46-76 x 203 cm	24" x 84" 61 x 213 cm
Optional Tabletop Size	22" x 80" 56 x 203 cm with facial cut-out	22" x 80" 56 x 203 cm with facial cut-out	22" x 80" 56 x 203 cm with facial cut-out	22" x 80" 56 x 203 cm with facial cut-out	22" x 80" 56 x 203 cm with facial cut-out	22" x 80" 56 x 203 cm with facial cut-out	23.5-30" x 80" 59-76 x 203 cm	NA
Imaging Area	66" 167.6 cm	66" 167.6 cm	62" 157.5 cm	62" 157.5 cm	62" 157.5 cm	59" 149.9 cm	72" 182.9 cm	62" 157.5 cm
Patient Capacity	450 lb. 204 kg	450 lb. 204 kg	450 lb. 204 kg	450 lb. 204 kg	450 lb. 204 kg	450 lb. 204 kg	450 lb. 204 kg	450 lb. 204 kg
Table Weight	250 lb. 113 kg	350 lb. 158 kg	395 lb. 179 kg	350 lb. 158 kg	425 lb. 193 kg	460 lb. 209 kg	490 lb. 222 kg	605 lb. 274 kg
Tabletop Pad (2" thick)	•	•	•	•	•	•	•	•
Restraint Straps	•	•	•	•	•	•	•	•
Facial Support Cushion	○	•	•	•	•	•	○	○
Hand Control	NA	•	•	•	•	•	•	•
Foot Control	NA	○	○	○	○	○	○	○
Tabletop Width Extender Board	Optional. For use with 22" or 24" wide tabletops only.						18" wide top only	NA
Armboard, rail mounted	○	○	○	○	○	○	NA	○
Armboard, carbon fiber	○	○	○	○	○	○	○	○
VAB Armboard	○	○	○	○	○	○	○	○
Clamp-on Accessory Rail	○	○	○	○	○	○	NA	○
Catheter Tray extension	NA	NA	NA	NA	NA	NA	○	○
Table-Mounted Radiation Shield	○	○	○	○	○	○	○	○

• Standard Feature

○ Optional



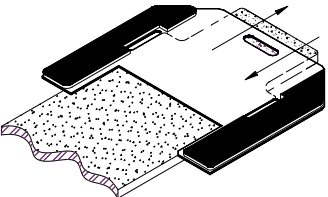

## Aspect Series Table Accessories

Refer to Tables Specification & Accessory Matrix for table compatibility and to identify optional accessories and those that are included with specific table models.

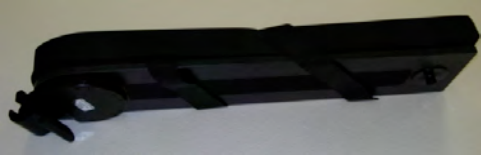

Catalog No.	Tabletop Extensions	
A100-435  A100-780	<p><b>ID410 Tabletop Width Extender Board, for 18" Top</b></p> <p><b>ID410 Tabletop Width Extender Board, for 22" Top</b></p> <p>Lateral arms support, includes pads</p> <ul style="list-style-type: none"> <li>• Slides over head-end of table.</li> <li>• Carbon fiber</li> <li>• Provides additional width for 18", or 22" wide Aspect tabletops.</li> </ul>	
A100-814  A100-1769	<p><b>Catheter Tray Extension for Aspect 100-4</b> Rail-attached extension / catheter tray for Aspect 100-4 vascular table.</p> <p><b>Catheter Tray Extension for Aspect 100-4T</b> Rail-attached extension/catheter tray for Aspect 100-4T vascular table. Dimensions: L = 29.75", W = 26.75"</p>	

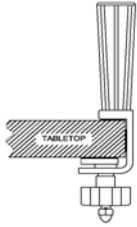
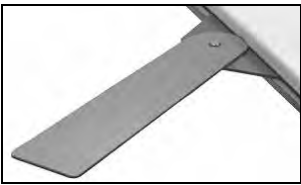
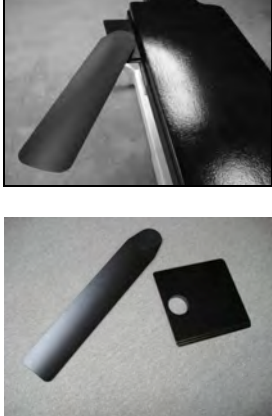
## Armboards and Rail-Mounted Accessories



A100-1007	<p><b>Clamp-On Accessory Rail</b> Clamps to Aspect Series carbon fiber tabletops to provide side-rail section for rail-mounted accessories. 3/8" x 1-1/8" rail. Note: Compatible with Aspect 100, 100E, 100R, 100T, 100RT and 100RTL table models.</p>	
A100-1770	<p><b>Clamp-On Accessory Rail for Aspect 100-4T Table</b> Clamps to carbon fiber tabletop. 3/8" x 1-1/8" rail.</p>	

<p>A310-056</p>	<p><b>Armboard, phenolic, rail-mounted</b> Pivoting armboard. Includes pad and strap. Requires clamp-on accessory rail above for use on Aspect 100, 100E, 100R, 100T, 100RT, 100RTL 100UC+ and 100-4T table models.</p>	
<p>A100-1711</p>	<p><b>Patient Handgrip, rail mounted, for Aspect High-Tilt Table</b></p>	
<p>A100-937</p>	<p><b>Patient Handgrip, clamp-on mount, for Aspect 100-EP Table</b></p>	
<p>A310-059</p>	<p><b>Armboard, carbon fiber, shoulder-mount, flat</b> (shown at right without pad) Single, pivoting armboard with pad and strap. Attaches by sliding the thin support section under patient shoulder and table pad. Design permits two armboards to be used simultaneously.</p>	
<p>A310-061</p>	<p><b>Armboard, 2-piece, carbon fiber, shoulder-mount with concave shaped armboard</b> Single, pivoting armboard with strap. Attaches by sliding the thin support section under patient shoulder and table pad. 2-piece design allows arm support to be removed from shoulder section for easy patient access and loading. Design permits two armboards to be used simultaneously.</p>	
<p>X100-1720 A100-1809</p>	<p><b>VAB Radiolucent Armboard for use with 1" tabletop pad</b> <b>VAB Radiolucent Armboard for use with 2" tabletop pad</b> (shown at right without tabletop and armboard pads) Ultra-sturdy and extra-wide, one-piece, carbon fiber armboard for vascular access and angiographic imaging of the arm. Body section slides under tabletop pad and held in place by patient's upper body. Includes pad &amp; strap.</p>	

### Radiation Shields, Table Mounted

A610-080	<p><b>Radiation Shield, 24 x 24, includes table clamp</b></p> <p>For Aspect Series tables without side-rails. Clamps to carbon fiber tabletop. Snap-on upper section above level of tabletop is removable. Multiple units may be used in combination to increase shielded area.</p>	
A610-051	<p><b>Radiation Shield, Articulating, Rail Mounted</b></p> <p>For Aspect 100-4 and 100-4T vascular tables. Attaches to table side-rail at base end of table. Articulating joint allows shield to conform to table contour. Snap-on upper section above level of tabletop is removable.</p>	

**Facial Support and Spinal Imaging Accessories**

<p>C000-0597</p>	<p><b>Facial Cushion, Crescent Shaped</b> Soft, patient facial support cushion for pain management procedures &amp; other patient prone positions. Can be used with tabletops that have or do not have built-in facial cutout.</p>	
<p>C000-0598</p>	<p><b>Disposable Covers for Crescent Shaped Facial Cushion</b> Box of 50</p>	
<p>C000-0822</p>	<p><b>Spine Positioning System</b> contains the components below.</p> <p>Package includes:          Frame with face rest (1): 12" x 33.5" (30 x 85 cm)          Crescent face pad (1): 12" (30 cm) diameter          Torso Support (1): 5.5" x 16" x 27" (14 x 30 x 58 cm)          Torso Wedge (2): 2.5" x 16" x 23" (6 x 41 x 58 cm)          Adjuster Pad (2): 1" x 7" x 12" (3 x 18 x 30 cm)          Adjuster Pad (2): 1" x 8" x 16" (3 x 20 x 41 cm)          8" ½ Round Ankle Bolster: 2" x 8" x 26" (5 x 20 x 66 cm)          8" Semi-Round Ankle Bolster: 6" x 8" x 26" (15 x 20 x 66 cm)</p>	



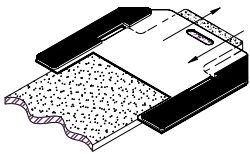

### Straps and Replacement Armboard Pads

C000-0328	<b>Patient Restraint Straps, pair, one 3" wide and one 5" wide</b> for all Aspect Series tables except Urology/Gyn models	
C000-0571	<b>Restraint Straps, pair, 3" wide, for Aspect Series Urology Tables</b>	
C000-0455	<b>Armboard Strap</b> Replacement strap for Armboards A310-056, A310-059 and A310-061	
X100-1655	<b>Armboard Pad, ½"</b> Replacement pad for Armboards A310-056 and A310-059 when used with 1" thick tabletop pad	
X100-1607	<b>Armboard Pad, 1.5"</b> For armboard A310—056 and A310-059 when used with 2" thick tabletop pad	
C000-0709 X100-1689 X100-1786	<b>VAB Armboard Strap</b> <b>VAB Armboard Pad for use with 1" thick tabletop pad</b> <b>VAB Armboard Pad for use with 2" thick tabletop pad</b>	
X100-1661	<b>Pad for ID410 Table Width Extender Board, 1", qty. 1</b> For use with 1" thick tabletop pad. (Extender board has 2 pads).	
X100-1755	<b>Pad for ID410 Table Width Extender Board, 2", qty. 1</b> For use with 2" thick tabletop pad. (Extender board has 2 pads).	





### Disposable Covers

C000-0492	<b>Disposable Covers for 100UC Footswitch</b> 24" x 20", box of 50
C000-0645	<b>Disposable Tabletop Protector for Aspect Series Urology Tables</b> Box of 20

### Urology Table Accessories: Leg Holders

C000-0695	<b>Boot-Style Legholders, Pneumatic Assist (pair)</b> Gas spring height adjustment. Includes pads. For patients up to 350 lbs. (159 kg). Requires 2 side rail clamps C000-0656 (see below).	
C000-0656	<b>Side-Rail Clamp with Blade-Style Socket (qty. of 1)</b> For Leg Holders C000-0695, and C000-0739.	
		
C000-0739	<b>Heavy Duty Boot-Style Legholders, Pneumatic Assist (pair)</b> Gas spring height adjustment. Includes pads. For patients up to 525 lbs. (239 kg). Requires 2 side rail clamps C000-0656 (see above)	
	<i>Shown at right with and without pad</i>	
C000-0745	<b>Basic Knee Crutches, (pair).</b> Includes doughy soft pads for reduced popliteal pressure. One easy-to-use handle provides vertical adjustment and 360° horizontal rotation. For patients up to 400 lbs. (181 kg). Requires 2 side-rail clamps C000-0746 (See below).	
C000-0746	<b>Rotating Side-Rail Clamp (qty. of 1) for Basic Knee Crutches</b> Easy to lock and rotate. (For use only with round post stirrup rods such as those on Basic Knee Crutches above).	
		<i>Basic Knee Crutches are recommended for Aspect <b>100US</b> table only. Not recommended for Aspect <b>100UC</b> table model.</i>

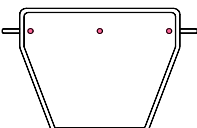

### Urology Table Accessories: Disposables and Replacement Items for Aspect 100U & 100UC

<p>C000-0595 C000-0593 C000-0594</p>	<p><b>Uro Drain Bag Support Hoop, collapsible</b> <b>Disposable Drain Bag and Hose Ass'y. box of 20</b> <b>Physician Elbow Supports (pair), with pads</b></p>	
<p>C000-0612</p>	<p><b>Disposable Drainage Collector, box of 10</b> Connects to drain bag hose for collection and disposal of drainage fluids. Converts drainage fluids to gel-like substance. Recommended for use in lieu of floor drains. 5 gallon capacity.</p>	
<p>Z100-1060</p>	<p><b>Removable Radiation Shield Drape</b> Replacement lead drape for perineal end of IDI urology tables. 0.5mm Pb equivalency.</p>	
<p>W100-1001</p>	<p><b>Radiographic Cassette Tray, Aspect 100U &amp; 100UC Tables</b>  (Was Q100-1121)</p>	

### Replacement Tabletop Pads

Some pads listed below are for older tabletop styles. Contact IDI for pad thicknesses and styles not shown below.  
Please note that armboard pad selections must correspond to tabletop pad thicknesses

#### Tabletop Pads for Aspect 100, 100E, 100R, 100T, 100RT, 100RTL & High-Tilt table models:

X100-1651 X100-1650	Tabletop Pad, 18 x 80 x 1" thick, bottleneck shape Tabletop Pad, 22 x 80 x 1" thick, bottleneck shape	
X100-1718 X100-1757	Tabletop Pad, 22 x 80 x 1" thick, tapered end, w/facial cutout Tabletop Pad, 22 x 80 x 2" thick, tapered end w/facial cutout	
X100-1825 X100-2008	Tabletop Pad, 24 x 80 x 1" thick, rectangular Tabletop Pad, 24 x 80 x 2" thick, rectangular	

#### Tabletop Pads for Aspect 100-4 table model:

X100-1648 X100-1780 X100-1215 X100-1767 X100-1091	Tabletop Pad; 18/30 x 80 x 1" thick, contoured shape Tabletop Pad; 18/30 x 80 x 2" thick, contoured shape Tabletop Pad; 23.5/30 x 80 x 1" thick, contoured shape Tabletop Pad; 23.5/30 x 80 x 2", contoured shape Tabletop Pad; 25/30 x 80 x 1", contoured shape	
---------------------------------------------------------------	------------------------------------------------------------------------------------------------------------------------------------------------------------------------------------------------------------------------------------------------------------------------------	--------------------------------------------------------------------------------------

#### Tabletop Pads for Aspect 100-4T table model:

X100-1664 X100-1781	Tabletop Pad, 24 x 84 x 1" thick, rectangular Tabletop Pad, 24 x 84 x 2" thick, rectangular	
------------------------	------------------------------------------------------------------------------------------------	--

#### Tabletop Pads for Aspect EP, FC and C table models:

X100-1654	Tabletop Pad, 22 x 84 x 1" thick, rectangular, for 100EP table
X100-824	Tabletop Pad, 22 x 84 x 1" thick, rectangular, for 100FC table
X100-1649 X100-1742	Tabletop Pad, 24 x 80 x 1" thick, rectangular, for 100-C table Tabletop Pad, 24 x 80 x 2" thick, rectangular, for 100-C table



#### Tabletop & Leg Extension Pads for Aspect Urology/Gyn Tables (verify tabletop width and table serial number prior to order):

X100-1652 X100-1818	Tabletop Pad, 28 x 46 x 1" thick, for 100U & 100UC tables Tabletop Pad, 28 x 46 x 2" thick, for 100U & 100UC tables
X100-1687	Tabletop Pad, 24 x 46 x 1" thick, for 100US and older model 100U tables
X100-1653 X100-1753	Pad for 100U & 100UC Leg Extension, 28 x 30 x 1 thick Pad for 100U & 100UC Leg Extension, 28 x 30 x 2" thick
X100-1606	Pad for 100UC Leg Extension, 28 x 34 x 2" thick

### Table Hand Controls

K000-0041	<b>Hand Control, for 100E, 100US</b>
K000-0054	<b>Hand Control, for 100R, 100T, 100EP</b>
K000-0195	<b>Hand Control, for 100RT</b>
K000-0197	<b>Hand Control, for 100RTL</b>
A270-126	<b>Hand Control, Panning, for 100-4</b>
A270-146	<b>Hand Control, Panning, for 100-4T</b>
K000-0112	<b>Hand Control, for 100U</b>
K000-0158	<b>Hand Control, for 100UC</b>

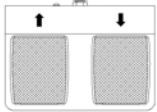
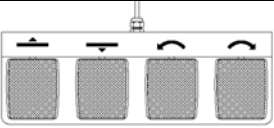
### Table Footswitch Controls

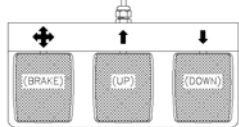
A100-1540	<b>Footswitch Control, for 100UC &amp; 100UC Plus</b> Circular center pedal controls 4-way tabletop motion. Outer rocker pedals control table elevate and tilt.	
A100-758	<b>Footswitch Control, for 100E, 100US</b>	
A100-1823	<b>Footswitch Control for Aspect High-Tilt model</b>	(2 button; same style as footswitch above)
A100-500	<b>Footswitch Control, for 100R, 100T, 100EP</b>	
A100-1960	<b>Footswitch Control, for 100RT</b>	(6 button; same style as 100RTL footswitch below)
A100-1961	<b>Footswitch Control, for 100RTL</b>	
A100-1533	<b>Footswitch Control, for 100U</b>	(6 button; same style as 100RTL footswitch above)
A100-1816	<b>Footswitch Control, 100-4T</b>	
A100-659	<b>Footswitch Control, for 100-4, 100FC, 100C</b>	

*IDI Aspect Series Tables are ETL Listed (IEC, UL & CSA Standards) and CE Marked.  
Technical Specifications are subject to change without notice.*

*Phone Number 978-829-0009  
Fax Number 978-829-0027  
Call Toll Free 877-304-5434*